



Sender V3 Getting Started Guide

Document Number: TN-9.1.3

Document Version: 1.0

Sender V3 Getting Started Guide

Table of Contents

1	Introduction	4
2	A Note about the Sender Board Self-Test.....	4
2.1	Sender Board Static Self-Tests	4
2.2	Sender Board Dynamic Self-Tests	4
3	Gathering Components for the Sender V3 System.....	5
3.1	Sender V3 System	5
3.2	Host Computer	5
3.3	NULL MODEM	5
3.4	RS-232 Cables.....	6
3.5	DCC Booster	6
3.6	Decoder	7
3.7	Test Jig.....	7
4	Connect and Verify the Host Computer.....	8
5	Verify the V3 Sender Board	9
6	Connect the DCC Components.....	9
7	Verify a Manual Decoder Test	11
8	Verify an Automated Decoder Test.....	12
9	Troubleshooting	14
9.1	Computer Host to V3 System Communication Problems	14
9.1.1	Problems Sending Characters To and From the V3 System.....	14
9.1.2	[C:\RESULTS] Is Not the Current Directory When the V3 System Powers Up.	14
9.2	V3 Sender Board Problems	15
9.2.1	The SEND.EXE Program Does Not Run When You Type the Send Command.....	15
9.2.2	The SEND.EXE Program Self-Test Fails	15
9.3	Overall Decoder Test System Problems.....	15
9.3.1	The LED Does Not Light Properly During the Manual Decoder Test.....	15
9.3.2	GEN Bit 0 Does Not Change State When the Decoder Changes Direction	16
9.3.3	The Decoder Fails Too Many Tests During the Automated Decoder Test.....	17
10	Additional Documents List	18
10.1	http://www.nmra.org/dcc-decoder-test-system	18
10.1.1	Sender Software Information	18
10.1.2	SenderV3 Board Hardware Information	18
10.2	TS-5300 Information	19
10.3	Test Equipment	19
11	Warranty and Service Information.....	19

Sender V3 Getting Started Guide

List of Figures

Figure 1: Sender V3 System Components.....	20
Figure 2: V3 System Power Adapter	21
Figure 3: V3 System Connectors	21
Figure 4: V3 System TS-5300.....	22
Figure 5: V3 System Sender Board.....	22
Figure 6: Device Manager	23
Figure 7: DB9F NULL MODEM.....	23
Figure 8: Example Test Jig	24
Figure 9: V3 System Power-On Screen	24
Figure 10: V3 System C:\RESULTS Directory	25
Figure 11: V3 System C:\SEND Directory	25
Figure 12: V3 System A: Directory	26
Figure 13: SEND.EXE Manual Mode.....	27
Figure 14: SEND.EXE Help Screen	27
Figure 15 SEND.EXE Automated Test.....	28
Figure 16: Serial Loopback Connection.....	29
Figure 17: Loopback Terminal Emulator Screen	29
Figure 18: Loopback Scope Trace.....	30
Figure 19: Scope Trigger Trace.....	30
Figure 20: DCC A – DCC B Trace	31
Figure 21: Booster Output Trace	31

List of Tables

Table 1: Configuration Variable Settings	7
--	---

Associated Documents

- [NMRA Decoder Test Files](https://app.box.com/s/7b93a06edb8f0f1cea35)
 - [TN9.1.1 NMRA DCC Decoder Test User Manual.pdf](#)
 - [TN9.1.2 Sender Board Theory of Operation.pdf](#)
- [Sender V2 System Document Folder](https://app.box.com/s/pfwr5yevja99bk1fpr1so5lli8n5mgbn)
 - [Sender V2 Schematic.pdf](#)
- [Sender V3 System Document Folder](https://app.box.com/s/vkkzel32wlmhs3nzktazhwrp6u5ibkke)
 - [Sender V3 Schematic Send104E.pdf](#)

Sender V3 Getting Started Guide

1 Introduction

Congratulations on your purchase of the NMRA Sender V3 Decoder Test System (V3 System for short). The V3 System is the third major revision of the NMRA Sender System, first introduced in 1994. The V3 System is fully stand-alone and no longer requires a PC to host the Sender Board using the ISA interface. Any Windows, Mac, or Linux computer can be used to control the V3 System, upload results, etc.

This document will get you up and running quickly with the V3 System and will also point you to the additional documents you will need to learn more about the V3 System and decoder testing.

I know you're anxious to get up and running, but take a few minutes to read through the remainder of this documents. It will save you a lot of debugging time down the road.

2 A Note about the Sender Board Self-Test

Because the V3 System is used to conformance tests decoders, it is very important that the Sender Board hardware be work properly. The V3 SEND.EXE program conducts a self-test of the Sender Board every time the SEND.EXE program starts. The program prints an error message to the screen and the log file and exits in case of an error. A decoder test cannot be done unless all the self-tests pass.

The only components the self-test cannot test are the RS-422 drivers and receivers.

The static and dynamic self-tests are summarized below.

2.1 Sender Board Static Self-Tests

The SEND.EXE program controls the clock during the static self-test phase. The SEND.EXE program will set the clock high or low and read back the value of 52 test points from the Sender Board. It then compares the Sender Board values against a test vector maintained by SEND.EXE. Any discrepancy will cause the SEND.EXE program to print an error message indicating the vector and values that did not match to the screen and the log file and exit.

The 52 self-test feedback points cover all major hardware components of the Sender Board. The self-test requires 200 test vectors and statically tests all major Sender Board functions.

2.2 Sender Board Dynamic Self-Tests

Once all static self-tests have passed, the SEND.EXE program tests the Sender Board 1 MHz clock. The board does this by initializing and starting the clock. It next counts the number of DCC 1 bits that occur in 1 second of time as read by the TS-5300 clock. It then counts the number of DCC 0 bits that occur in 1 second. If either the count of 0 bits or 1 bits is too far out of range, the SEND.EXE program prints an error message to the screen and log file and exits.

Sender V3 Getting Started Guide

3 Gathering Components for the Sender V3 System

You will need to obtain and configure several components to set up a complete decoder test system. This section will give details on these components.

“Figure 1: Sender V3 System Components” is a block diagram on the V3 System components.

3.1 Sender V3 System

The other components in this section connect directly or indirectly to the V3 System. The following figures detail the V3 System:

“Figure 2: V3 System Power Adapter”

This photo shows an external view of the V3 System showing the +5 VDC Power Adapter.

“Figure 3: V3 System Connectors”

This photo shows an external view of the V3 System RS-232 and Sender I/O connector.

“Figure 4: V3 System TS-5300”

This photo shows an internal view of the V3 System with the Sender Board removed to show the TS-5300 Embedded Computer.

“Figure 5: V3 System Sender Board”

This photo shows an internal view of the V3 System with the Sender Board installed.

3.2 Host Computer

The Host Computer provides the user interface for the V3 System and stores test results. The Host Computer must meet these requirements:

- Run a Windows, Mac, or Linux operating system and graphical user interface.
- Have sufficient free disk space to store decoder test results.
- Support an RS-232 interface capable of 115200 BAUD or a USB interface capable of supporting a USB to RS-232 adapter such as the Trendnet TU-SP detailed at this Website: http://trendnet.com/langen/products/proddetail.asp?prod=265_TU-S9
- Support a terminal emulator program to communicate with the V3 System. This terminal emulator must support the ZMODEM protocol to transfer files to and from the V3 System. One good list of terminal emulators is at http://en.wikipedia.org/wiki/List_of_terminal_emulators.

3.3 NULL MODEM

The V3 System has an RS-232 DB9P DTE interface. Most Host Computers or USB to RS-232 adapters also have an RS-232 DB9P DTE connector. You will need a NULL MODEM to connect the 2 DTE interfaces together. You can purchase a NULL MODEM adapter or a NULL MODEM cable. Examples are:

Adapter: <http://amzn.to/YXUqSH>

Cable: <http://amzn.to/1AW9Jc3>

You can also wire your own NULL MODEM cable or adapter. “Figure 7: DB9F NULL MODEM” shows how to wire a NULL MODEM.

Sender V3 Getting Started Guide

3.4 RS-232 Cables

Depending on your configuration, you may need one or more 9 pin serial cables to connect the V3 System to the NULL MODEM adapter, etc.

3.5 DCC Booster

You will need a DCC booster to connect to the V3 System and the decoder. There are 3 types of decoder used for decoder testing. You should use a Conforming Booster for the initial tests.

The 3 decoder types are listed below:

- | | |
|---------------------------------|--|
| Conforming Booster | This is a standard commercial DCC booster. It is safest to use a booster with a conformance warrant. The list of boosters with conformance warrants is at NMRA Warrant List . Most boosters will work as long as they conform to S-9.1.2 . An opto-isolated booster is not necessary but will work fine. |
| Noise-Injecting Booster | The Noise-Injecting Booster tests decoder with minimum track Voltage, maximum rise time, and added 100 KHz noise. Information on the Noise-Injecting Booster is in the <code>.\HW\BOOSTER\Noise_Injecting\</code> directory of the https://app.box.com/s/tk4mgzhyrni6kihyvs9w archive file. |
| Glitch-Injecting Booster | The Glitch-Injecting Booster tests decoder with a ring glitch at the zero crossing. Information on the Glitch-Injecting Booster is in the <code>.\HW\BOOSTER\Glitch_Injecting\</code> directory of the https://app.box.com/s/tk4mgzhyrni6kihyvs9w archive file. |

Sender V3 Getting Started Guide

3.6 Decoder

You should get a conforming mobile decoder with a motor output for the verification test. A list of conforming decoders is at [NMRA Warrant List](#).

The standard Configurations Variables (CVs) should be set as shown in the table below. Refer to http://www.nmra.org/sites/default/files/s-9.2.2_2012_10.pdf for information on CVs

Any custom features that might affect the ability of the decoder output to change states (such as back EMF) should be turned off.

CV	Name	Value (Decimal)	Description
1	Primary Address	3	Short Address
2	Vstart	0	Start Voltage
3	Acceleration Rate	0	Acceleration Rate
4	Deceleration Rate	0	Deceleration Rate
5	Vhigh	0	Maximum Voltage
6	Vmid	0	Mid-point Voltage
29	Configuration Variable #1	2	Bit 0 = 0 – Normal Direction Bit 1 = 1 – Use 28 Speed Steps Bit 2 = 0 – Power Conversion Off Bit 3 = 0 – Bi-Directional Communication Off Bit 4 = 0 – Use Vstart, Vmid, Vhigh Bit 5 = 0 – One Byte Addressing Bit 6 = 0 – Reserved Bit 7 = 0 – Multifunction Decoder

Table 1: Configuration Variable Settings

3.7 Test Jig

The Test Jig is shown in “Figure 1: Sender V3 System Components.” The Test Jig connects the decoder track inputs to the booster track outputs and the filtered decoder output (motor, accessory, or function) to the V3 System DB25S connector. A photo of an example Test Jig is at “Figure 8: Example Test Jig.”

Sender V3 Getting Started Guide

4 Connect and Verify the Host Computer

You'll start by connecting the V3 System to the Host Computer and verifying that they play well together. You should see "9.1 Computer Host to V3 System Communication Problems" if you run into problems.

A photo showing the V3 System Power Adapter is at "Figure 2: V3 System Power Adapter."

A photo showing the V3 System connectors is at "Figure 3: V3 System Connectors."

The steps to connect the V3 System to Host Computer are below:

1. Do not connect to the V3 System DB25S connector until the next section.
2. Install a Terminal Emulator if necessary.
3. Install the USB to RS-232 Adapter if the Host Computer does not have a serial port. Make note of which serial port is connected to the V3 System.
4. Connect the cables as shown in "Figure 1: Sender V3 System Components."
Do not connect the V3 System Power Adapter to AC power yet.
5. Start the Terminal Emulator and connect it to the serial port you have connected to the V3 System. Make sure you pick the correct serial port. "Figure 6: Device Manager" shows the Windows Device Manager with COM6 used to connect to the V3 System.

Configure your Terminal Emulator as follows:

BAUD Rate: 115200
Date Length: 8 bits
Parity: None
Stop Bits: 1
Flow Control: None

6. Apply power to the V3 System. You should get a screen of data similar to "Figure 9: V3 System Power-On Screen."
7. Make certain the current directory is [C : \RESULTS].
8. Type "**dir**<CR>" at the command prompt. You should get a screen similar to "Figure 10: V3 System C:\RESULTS Directory"
9. Type "**dir . . \send**<CR>" at the command prompt. You should get a screen similar to "Figure 11: V3 System C:\SEND Directory"
10. If the previous steps have worked properly, go on to the next section. If you have problems, go to "9.1 Computer Host to V3 System Communication Problems" and correct any problems before proceeding.

Sender V3 Getting Started Guide

5 Verify the V3 Sender Board

1. Once the V3 System is talking to the Host Computer, you'll verify that the V3 Sender Board is working properly. You should see "5 Repeat "4 Connect and Verify the Host Computer" and see if it passes. If you still get a failure, return the V3 System for warranty service as explained by "11 Warranty and Service Information."

V3 Sender Board Problems" if you run into problems.

Refer to "Figure 13: SEND.EXE Manual Mode" for the Terminal Emulator command flow for a manual test.

The steps to verify the Sender Board are below:

1. Start the Terminal Emulator and connect it to the V3 System.
2. Start the SEND.EXE program in manual mode by entering "**send -m**" on the Terminal Emulator command line.
3. Enter "**temp**" for the file name.
4. Enter "**x**" for the Manufacturer.
5. Enter "**x**" for the Model number.
6. Enter "**x**" for the Serial number.
7. Enter a single Period "." Into the Comments section.
8. The SEND.EXE program will conduct self-tests and enter manual mode. Verify the self-tests have passed and that the program has entered manual mode.
9. Press the "**d**" key to cause the SEND.EXE program to send a stream of DCC command packets to the decoder.
10. Press the "**f**" key to change the state of the decoder output.
11. Press the "**q**" key to exit the SEND.EXE program.
12. Disconnect the Terminal Emulator from the V3 System and exit the Terminal Emulator program.
2. If the previous steps worked properly, go on to the next section. If you have problems, go to "5 Repeat "4 Connect and Verify the Host Computer" and see if it passes. If you still get a failure, return the V3 System for warranty service as explained by "11 Warranty and Service Information."
13. V3 Sender Board Problems" and correct any problems before proceeding.

6 Connect the DCC Components

Once the V3 System hardware is verified, you'll connect the DCC components.

Refer to "Figure 1: Sender V3 System Components" to see how the DCC components are connected.

Warning: You must only ground signals marked GND in the above figure. This includes all pins on the V3 System not marked GND, all Booster pins not marked GND, all Decoder pins, and all Test Jig pins. Doing so may cause invalid test results and could damage the equipment.

The steps to verify the V3 System hardware are below:

1. Connect the V3 System DB25S DCC A (2), DCC B (3), and GND (1) leads to the booster inputs.
2. Connect the booster outputs to the decoder track inputs via the Test Jig.

Sender V3 Getting Started Guide

3. Connect the filtered decoder output on the Test Jig to the V3 System IN0 A (9) and IN0 B (10) tester inputs.
4. You can connect an oscilloscope to the decoder test system. Connect scope probe channel 1 to booster TRACK A. Connect scope probe channel 2 to booster TRACK B. Connect the scope external trigger probe to V3 System Scope A (5). All scope probe grounds should be connected to one of the V3 System GND pins. Once the scope probes are connected, configure the scope for channel 1 – channel 1 differential mode and for external trigger.

Sender V3 Getting Started Guide

7 Verify a Manual Decoder Test

Once the DCC components are connected, you'll verify that the overall decoder test system can conduct a manual decoder test. You should see "9.3 Overall Decoder Test System Problems" if you run into problems.

Refer to "Figure 13: SEND.EXE Manual Mode" for the Terminal Emulator command flow for a manual test.

The steps to verify the V3 System hardware are below:

1. Start the Terminal Emulator and connect it to the V3 System.
2. Start the SEND.EXE program in manual mode by entering "**send -m**" on the Terminal Emulator command line.
3. Enter "**temp**" for the file name.
4. Enter "**x**" for the Manufacturer.
5. Enter "**x**" for the Model number.
6. Enter "**x**" for the Serial number.
7. Enter a single Period "." Into the Comments section.
8. The SEND.EXE program will conduct self-tests and enter manual mode. Verify the self-tests have passed and that the program has entered manual mode.
9. Press the "**d**" key to cause the SEND.EXE program to send a stream of DCC command packets to the decoder.
10. Verify the **IN0A** input Voltage is positive relative to the **IN0B** input. The Test Jig LED should be **Red**. Press the "**h**" key. Verify GEN bit 0 is 1. See "Figure 13: SEND.EXE Manual Mode" for the location of GEN bit 0.
11. Press the "**f**" key to change the state of the decoder output.
12. Verify the **IN0A** input Voltage is negative relative to the **IN0B** input. The Test Jig LED should be **Green**. Press the "**h**" key. Verify GEN bit 0 is 0.
13. Press the "**q**" key to exit the SEND.EXE program.
14. Disconnect the Terminal Emulator from the V3 System and exit the Terminal Emulator program.
15. If the previous steps worked properly, go on to the next section. If you have problems, go to "9.3 Overall Decoder Test System Problems" and correct any problems before proceeding.

Sender V3 Getting Started Guide

8 Verify an Automated Decoder Test

Once the decoder manual test has past, you'll verify that the overall decoder test system can conduct an automated decoder test. You should see "9.3 Overall Decoder Test System Problems" if you run into problems.

Refer to "Figure 15 SEND.EXE Automated Test" for the Terminal Emulator command flow for an example of an automated test of a locomotive decoder.

The steps to verify the overall decoder test system are below:

1. Start the Terminal Emulator and connect it to the V3 System.
2. Start the SEND.EXE program in automatic mode by entering "send" on the Terminal Emulator command line.
3. Enter {File} for the file name. {File} must meet the file name requirements of the DOS 8.3 format. The SEND.EXE program will create 2 files named {File}.sum and {File}.log. The {File}.sum file summarizes the tests results. The {File}.log file provides details on test failures. The {File} in the example is "AH101_4N".
4. Enter {Manufacturer} for the manufacturer. This is a character string that identifies the decoder manufacturer. The {Manufacturer} in the example is "Acme".
5. Enter {Model} for the Model number. This is a string that identifies the model number of the decoder. The {Model} in the example is "H101".
6. Enter {Version} for the Serial number. This is a string that identifies the version number of the decoder. This is normally the value of CV7. If the version number is from CV7, it should be written in the form "CV7=nnn" where "nnn" is the version number from 1 to 255. The {Version} in the example is "CV7=13".
7. Enter information in the Comments section. The Comments section allows multiple row of text. The comments are terminated by entering a line with a single Period "." character. The Comments section should follow this format:

```
{Booster Type}, {CVs Changed}
{Track Polarity}
{Other Comments}
.
```

{Booster Type} denotes the type of booster used. Allowed values are "Conforming Booster", "Noise-Injecting Booster", and "Glitch Injecting Booster".

{CVs Changed} denotes any changes made to the CVs prior to the test.

{Track Polarity} denotes the polarity of the track inputs to the <Decoder>. Allowed values are "Normal Leads", and "Reverse Leads".

{Other Comments} is optional and should be used to indicate any other configuration changes made to the <Decoder>, any special test jig configuration, etc.

The comments section in the example is:

```
Conforming Booster, CV29=2 from 6
Normal Leads
.
```

8. The SEND.EXE program will conduct the self-tests and start the automated test suite. Verify the self-tests have passed and that the program has started the automated test suite.

Sender V3 Getting Started Guide

9. The automated tests take approximately 24 hours to complete. If necessary, you can stop the automated tests early by typing the 'ESCAPE' (<ESC>) character followed by the 'q' character. This will stop the automated tests and enter manual mode. Typing the 'q' character will exit the program.
Note: The TS-5300 used by the Sender V3 system does not buffer characters. You must wait at least 3 seconds between typing the 'ESCAPE' character and the 'q' character to reliably stop the automated tests. If the automated tests fail to stop on the first try, repeat typing the characters until the automated tests stop.
10. When the tests are complete, upload the **{File}.sum** and **{File}.log** file using the ZMODEM protocol. The Terminal Server command to do this is dependent on the Terminal Server used. The V3 System command to do this is:
[C:\RESULTS]ul {File}.*
The results files should be stored on the Host Computer in a subdirectory named **{Manufacturer}**. Other storage methods are allowed as long as they make it easy to find a decoder test for a given **{Manufacturer}** and **{Model}**.
Review the **{File}.sum** and **{File}.log** file to determine if the decoder passed the baseline test suite. A decoder must pass at least 95% of each packet acceptance test. A decoder must pass 100% of all other tests.
11. If the decoder passed the baseline tests, your system is ready to test decoders. If you have problems, go to "9.3 Overall Decoder Test System Problems" and correct any problems before attempting to test decoders.

Sender V3 Getting Started Guide

9 Troubleshooting

This section will help you troubleshoot problems you may run in to as you connect the V3 System to the other components and verify the decoder test system operation. You should choose the troubleshooting section that most closely matches your problem.

9.1 Computer Host to V3 System Communication Problems

9.1.1 Problems Sending Characters To and From the V3 System

Do the following steps if you get no or garbage characters when you apply power to the V3 System or if the V3 System fails to respond to keyboard commands.

1. Disconnect the DB9S connector of the RS-232 cable from the V3 system.
2. Set up the Terminal Emulator following the steps in “4 Connect and Verify the Host Computer.”
3. Verify you get no characters on the Terminal Emulator screen when you type characters on the keyboard. If you do, turn off “Local Echo” in your Terminal Emulator.
4. Connect a jumper between pins 2 and 3 of the DB9S you disconnected in step 1. Connect probe 1 of the oscilloscope to the jumper and connect the probe ground to pin 5. See “Figure 16: Serial Loopback Connection” for a picture of this set up.
5. If you don’t get the proper characters on the Terminal Emulator screen when you type characters on the keyboard, recheck your Terminal Emulator configuration, USB to RS-232 adapter configuration if used, and the serial connections between the components.
6. If you get the proper characters on the Terminal Emulator screen when you type characters on the keyboard, Check the signal with the oscilloscope and verify the start bit character is approximately 8.7 μ s wide. See “Figure 18: Loopback Scope Trace” for an example trace. If you get inappropriate bit times, recheck your Terminal Emulator BAUD rate.
7. If you get proper characters and bit times, it is possible that components have worked loosed inside the V3 System. Using proper ESD procedure, open the V3 System and make sure the TS-5300, CF card, V3 System, and the 2 ribbon cables are properly seated. See “Figure 4: V3 System TS-5300” and “Figure 5: V3 System Sender Board” for internal views of the V3 System.
8. Reassemble the V3 System when you are done.
9. Repeat “4 Connect and Verify the Host Computer” and see if it passes. If you still get a failure, return the V3 System for warranty service as explained by “11 Warranty and Service Information.”

9.1.2 [C:\RESULTS] Is Not the Current Directory When the V3 System Powers Up.

Do the following if you get the proper power up screen and can send commands to the V3 System but are not in the [C:\RESULTS] directory.

3. If you get proper characters and bit times but cannot see the [C:\RESULTS] directory, it is possible that components have worked loosed inside the V3 System. Using proper ESD procedure, open the V3 System and make sure the TS-5300, CF card, V3 System, and the 2 ribbon cables are properly seated. See “Figure 4: V3 System TS-5300” and “Figure 5: V3 System Sender Board” for internal views of the V3 System.
4. Reassemble the V3 System when you are done.
5. Repeat “4 Connect and Verify the Host Computer” and see if it passes. If you still get a failure, return the V3 System for warranty service as explained by “11 Warranty and Service Information.”

Sender V3 Getting Started Guide

9.2 V3 Sender Board Problems

9.2.1 The SEND.EXE Program Does Not Run When You Type the Send Command

1. Type "**dir** ..\send<CR>" at the command prompt. Double-check that the screen resembles "Figure 11: V3 System C:\SEND Directory" and that the SEND.EXE program is in the list.
2. Type "**path**" and verify that **C:\SEND** is in the path.
3. Make note of the failures and return the V3 System for warranty service as explained by "11 Warranty and Service Information."

9.2.2 The SEND.EXE Program Self-Test Fails

1. If the SEND.EXE program exits with a self-test error, it is possible that components have worked loosed inside the V3 System. Using proper ESD procedure, open the V3 System and make sure the TS-5300, CF card, V3 System, and the 2 ribbon cables are properly seated. See "Figure 4: V3 System TS-5300" and "Figure 5: V3 System Sender Board" for internal views of the V3 System.
2. Reassemble the V3 System when you are done.
3. Repeat "7 Verify a Manual Decoder Test" and see if it passes. If you still get a failure, upload the .log file and print it out to return with the unit. Then return the V3 System for warranty service as explained by "11 Warranty and Service Information."

9.3 Overall Decoder Test System Problems

9.3.1 The LED Does Not Light Properly During the Manual Decoder Test

The most likely problem is a wiring error of the DCC Components or an improperly configured decoder. Do these steps to troubleshoot the problem:

1. Disconnect the DB25P cable from the V3 System.
2. Connect the channel 1 oscilloscope probe to V3 System DB25S connector pin 2 (DCC A). Connect the probe ground to DB25S connector pin 1 (GND).
3. Connect the channel 2 oscilloscope probe to V3 System DB25S connector pin 5 (SCOPE A). Connect the probe ground to DB25S connector pin 4 (GND).
4. Configure the oscilloscope as follows:

Channel 1:	2 V/Div, DC coupled.
Channel 2:	2 V/Div, DC coupled.
Display:	Channel 1 and Channel 2.
Sweep:	40 μ s/Div.
Trigger:	Channel 2, Falling Slope, DC coupled, automatic sweep, 2.0 V level.
5. Follow the steps in "5 Verify the V3 Sender Board" to generate a DCC signal.
6. Verify the oscilloscope trace is similar to "Figure 19: Scope Trigger Trace." If this test fails, return the V3 System for warranty service as explained by "11 Warranty and Service Information."
7. If the above step passes, move the channel 1 probe to DB25S connector pin 3 (DCC B). The trace should be similar to "Figure 19: Scope Trigger Trace" except the channel 1 trace should be inverted. If this test fails, return the V3 System for warranty service as explained by "11 Warranty and Service Information."
8. If the above steps pass, reconnect the scope probe leads to the DB25S connector. Connect the channel 1 probe to pin 2 (DCC A). Connect the channel 2 probe to pin 3 (DCC B). Connect the external trigger probe to pin 5 (SCOPE A). Connect the external probe ground to pin 4 (GND).

Sender V3 Getting Started Guide

9. Configure the oscilloscope as follows:

Channel 1:	5 V/Div, DC coupled.
Channel 2:	5 V/Div, DC coupled.
Display:	Differential Channel 1 – Channel 2.
Sweep:	200 μ s/Div.
Trigger:	External, Falling Slope, DC coupled, automatic sweep, 2.0 V level.

10. Verify the oscilloscope trace is similar to “Figure 20: DCC A – DCC B Trace.” If this test fails, return the V3 System for warranty service as explained by “11 Warranty and Service Information.”
11. Connect the positive end of a 1.5 V battery to the DB25S connector pin 9 (IN0 A). Connect the negative end of the battery pin 10 (IN0 B).
12. Press the “**d**” key to make sure the decoder direction is forward.
13. Press the “**h**” key. Verify GEN bit 0 is 1. See “Figure 14: SEND.EXE Help Screen” for the location of GEN bit 0.
14. Reverse the polarity of the 1.5 V battery.
15. Press the “**h**” key. Verify GEN bit 0 is 0.
16. If GEN bit 0 failed for either polarity, return the V3 System for warranty service as explained by “11 Warranty and Service Information.”
17. If the above tests have passed, the V3 System hardware appears to be working properly. Reconnect the DB25P end of the DB25 cable to the V3 System.
18. Connect the external trigger probe to the pin 5 (SCOPE A) at the opposite end of the DB25 cable that connects to the V3 System. Connect the external probe ground to pin 4 (GND).
19. Trace the DCC signal along the signal path. The booster input should look like “Figure 20: DCC A – DCC B Trace.” The output of the booster and the input to the decoder should look like “Figure 21: Booster Output Trace.”
20. If the signal to the decoder looks correct, verify that the output pair changes from positive to negative when the “**f**” key is pressed. If the decoder does not respond, verify the decoder is configured properly or try another decoder.
21. If the decoder output is correct, verify that the Test Jig is wired properly. The LED should be **Red** when the decoder direction is forward and **Green** when the decoder direction is reverse.
22. If the LED still fails, contact the NMRA for help. Follow these steps
 - a. Quit the SEND.EXE program.
 - b. Upload the .sum and .log files from the test.
 - c. Send an Email to tech-chair@hq.nmra.org requesting support. List all the DCC components used and attach the .log and .sum files.

9.3.2 GEN Bit 0 Does Not Change State When the Decoder Changes Direction

If the LED on the Test Jig is responding properly, troubleshoot the signal between the Test Jig LED and the V3 System.

1. Check the filtered decoder output with the channel 1 and channel 2 differential pain probes. The signal should be above +1 V when the decoder direction is forward and below -1 V when the decoder direction is reverse.

Sender V3 Getting Started Guide

2. Check filtered decoder output where it connects to the V3 system. Connect the channel 1 probe to pin DB25S connector pin 9 (IN0 A). Connect the channel 2 probe to pin 10 (IN0 B). The differential signal should be above +1 V when the decoder direction is forward and below -1 V when the decoder direction is reverse.
3. If GEN bit 0 still fails, contact the NMRA for help. Follow these steps
 - a. Quit the SEND.EXE program.
 - b. Upload the .sum and .log files from the test.
 - c. Send an Email to tech-chair@hq.nmra.org requesting support. List all the DCC components used and attach the .log and .sum files.

9.3.3 The Decoder Fails Too Many Tests During the Automated Decoder Test

Follow these steps if the decoder passed the static verification test but failed too many of the automated tests.

1. Check the .sum file and see if any tests passed. If all tests failed, make certain the decoder output or Sender V3 input signals are correct. You might try reversing the decoder output pins to see if tests start passing. If the tests start passing, make sure you haven't swapped the signals between the decoder output and the V3 System input.
2. If the decoder still fails all tests, verify the decoder is configured correctly or try a different booster and decoder. Make certain the booster and decoder have NMRA Conformance Warrants.
3. If some or many tests pass, the overall wiring is probably correct. Verify the decoder is configured correctly or try a different booster and decoder. Make certain the booster and decoder have NMRA Conformance Warrants.
4. If the automated test still has some or many passes but not enough to pass conformance, contact the NMRA for help. Follow these steps
 - a. Run a complete automated test.
 - b. Upload the .sum and .log files from the test.
 - c. Send an Email to tech-chair@hq.nmra.org requesting support. List all the DCC components used and attach the .log and .sum files.

Sender V3 Getting Started Guide

10 Additional Documents List

This section lists the additional documents that relate to the V3 System. Some documents are mandatory reading if you want to run decoder tests. Other documents are for reference and give you more information on the V3 System, etc. The following list will indicate which documents are mandatory and which are for reference.

Note: Links in red have not been uploaded to the Web yet.

10.1 <http://www.nmra.org/dcc-decoder-test-system>

This section lists the documents in the Website of the NMRA decoder test system shown above.

Mandatory: [Baseline Test Procedures in .pdf format \(Adobe Acrobat\)](#)
Overall baseline testing procedure.

Mandatory: [Locomotive Decoder Questionnaire](#)
Questionnaire that must be submitted when a locomotive or functional decoder is submitted for formal conformance testing by the NMRA.

Mandatory: [Accessory Decoder Questionnaire](#)
Questionnaire that must be submitted when an accessory or functional decoder is submitted for formal conformance testing by the NMRA.

10.1.1 Sender Software Information

This section lists the documents, source code, and other files related to the decoder test software.

Mandatory: [Sender Software User Guide](#)
User guide for the Sender Software that runs on the TS-5300 and controls the baseline decoder tests.

10.1.2 SenderV3 Board Hardware Information

This section lists the documents related to the Sender V3 Board that connects to the TS-5300 using its PC/104 client interface.

Reference: [Sender V3 Board Schematic](#)
Schematic for the V3 Sender Board.

Reference: [NMRA C&I DCC Test Board Theory of Operation](#)
Theory of operation for the Sender board used in the V3 System.

Reference: [Decoder Test Board Manual](#)
User manual for Sender V1 and V2 system. These systems are software equivalent to the Sender V3 system but used a PC compatible computer with an ISA slot in place of the TS-5300.

Sender V3 Getting Started Guide

10.2 TS-5300 Information

This section gives details on the Technologic Systems TS-5300 embedded computer. This off-the-shelf computer connects to the Sender V3 Board using its PC/104 host interface.

Reference: <http://www.embeddedarm.com/products/board-detail.php?product=TS-5300#>
Home Website of the Technologic Systems TS-5300 embedded computer used in the V3 System. You can link to detailed hardware and software information on the TS-5300 from the Website.

Reference: <http://wiki.embeddedarm.com/wiki/TS-5300>
Support Wiki for the TS-5300.

Reference: http://wiki.embeddedarm.com/wiki/Getting_Started_with_DOS
Gives a brief introduction to using the TS-5300 with DOS.

Reference: <http://www.embeddedarm.com/documentation/third-party/x86-dos-rom-41.pdf>
Embedded DOS user manual for the TS-5300.

Reference: <ftp://ftp.embeddedarm.com/old/old-software-pages/Manuals/EBIOS-UM.PDF>
BIOS user manual for the TS-5300.

10.3 Test Equipment

Reference: An oscilloscope is invaluable for troubleshooting system components and is required to set up the Noise-Injecting Booster. The oscilloscope must have 2 analog input channels that can be used in differential mode and an external trigger channel. The minimum bandwidth is 20 MHz. The oscilloscope used to prepare this document is a Tektronix DPO2002B (<http://www.tek.com/oscilloscope/mso2000-dpo2000>).

11 Warranty and Service Information

The V3 System Sender Board is warranted by the NMRA for 1 for parts and service.

Follow these steps to obtain warranty service:

1. Send an Email to tech-chair@hq.nmra.org to make arrangements for warranty service.
2. Write down which verification steps failed and include a print out of the .log file if the SEND.EXE program failed with a self-test error.
3. Securely package the V3 System and send it to the address given in step 1 above. Postage must be paid by the customer.
4. A repaired or replacement unit will be returned to you at no cost.

Sender V3 Getting Started Guide

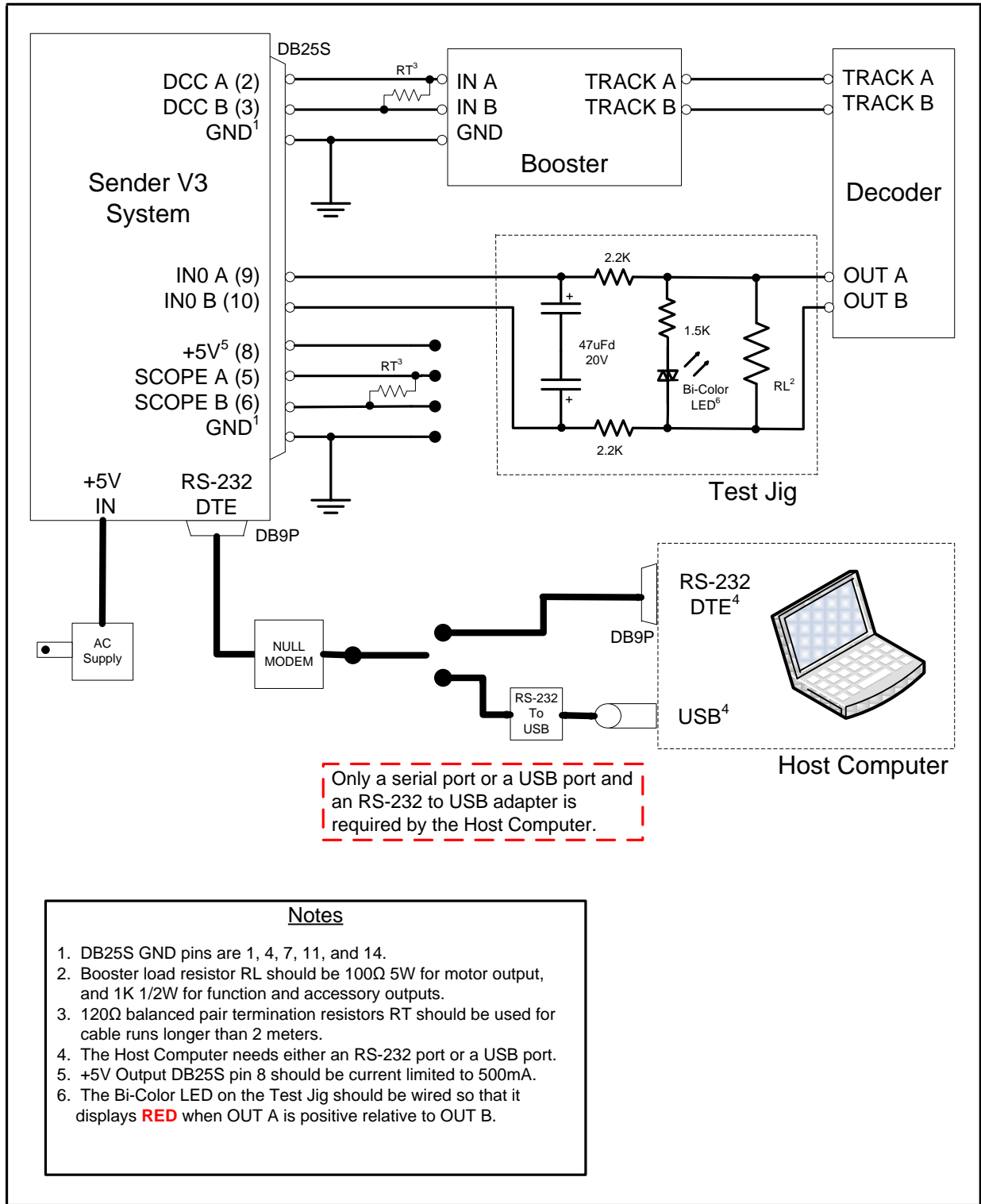

Figure 1: Sender V3 System Components

Sender V3 Getting Started Guide



Figure 2: V3 System Power Adapter

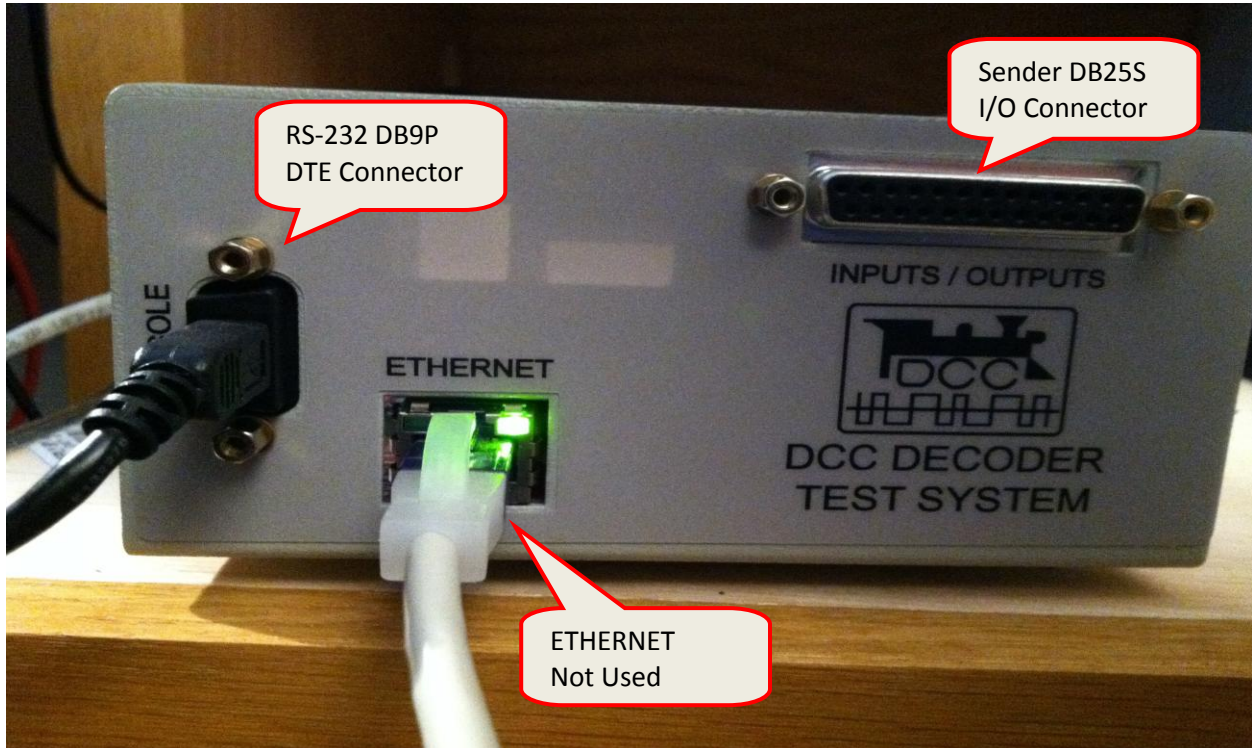

Figure 3: V3 System Connectors

Sender V3 Getting Started Guide

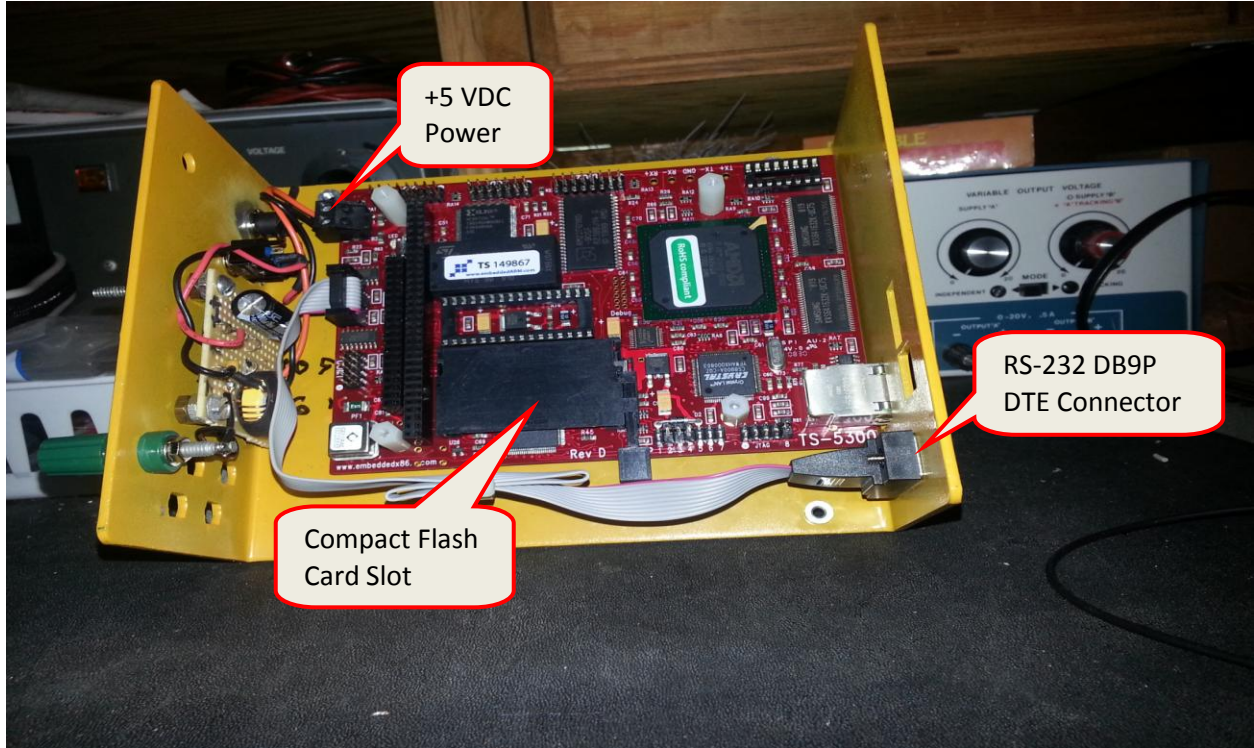

Figure 4: V3 System TS-5300

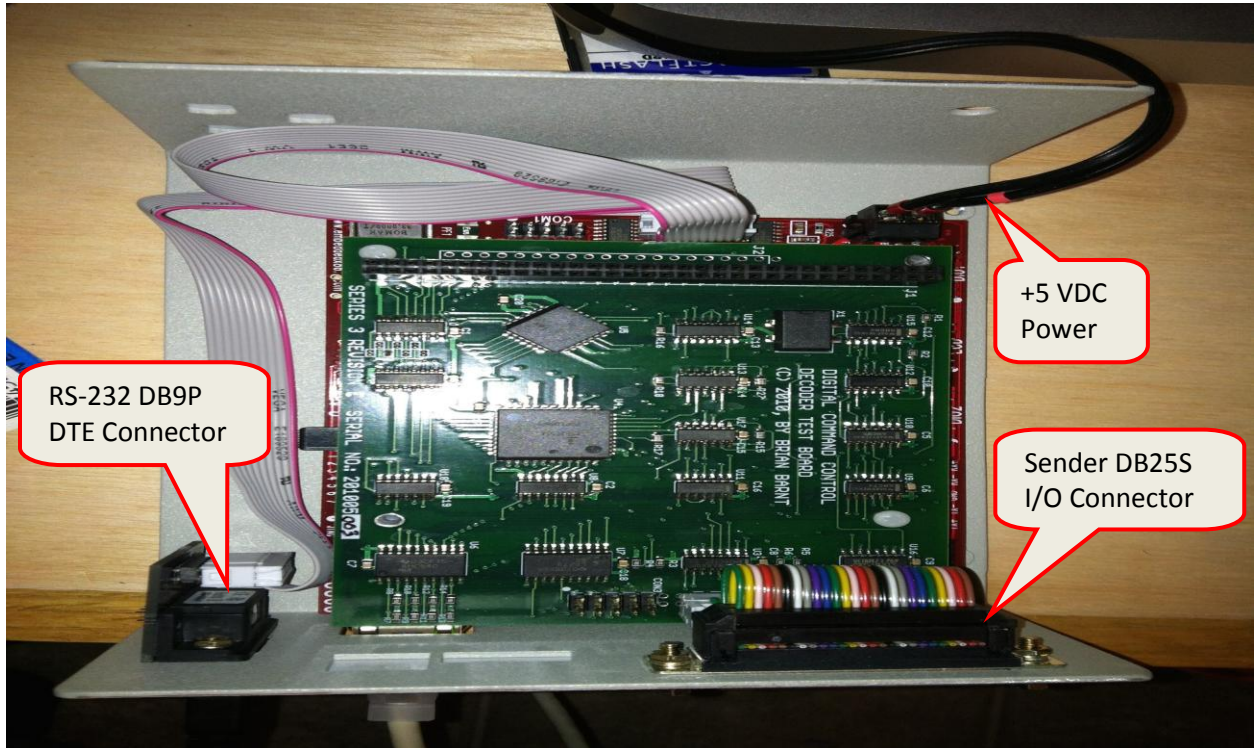

Figure 5: V3 System Sender Board

Sender V3 Getting Started Guide

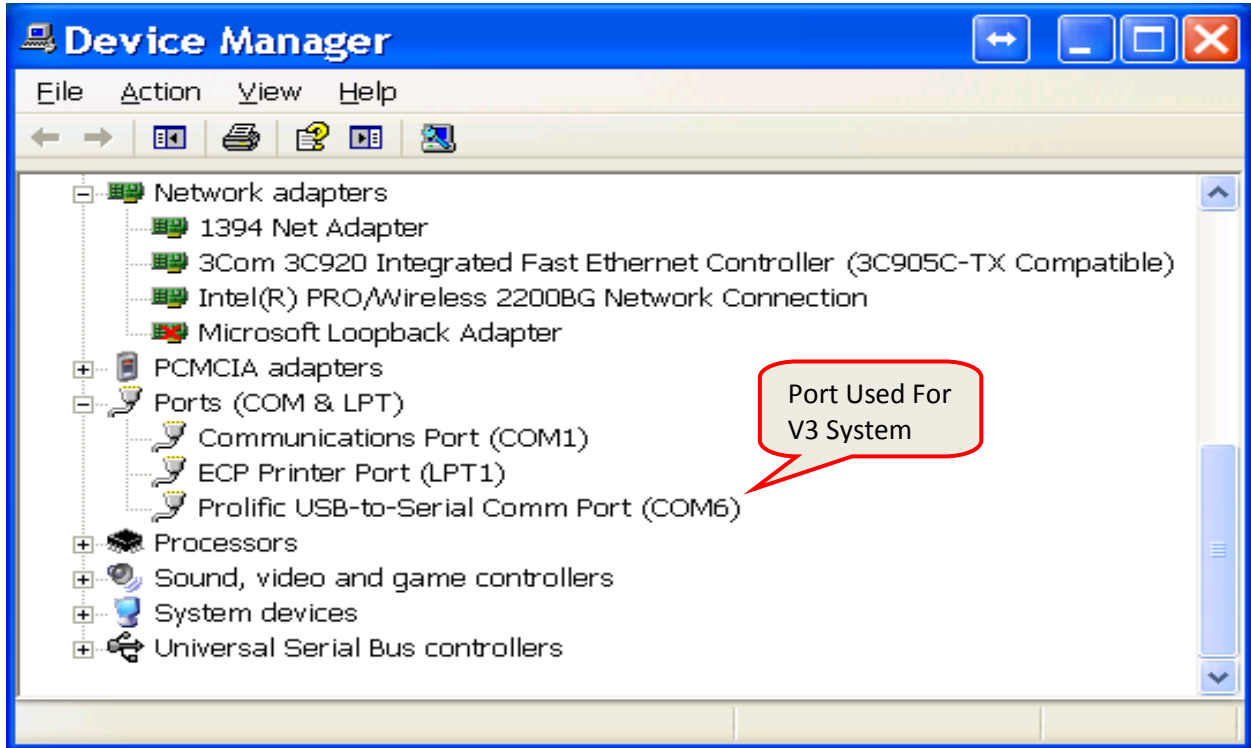

Figure 6: Device Manager

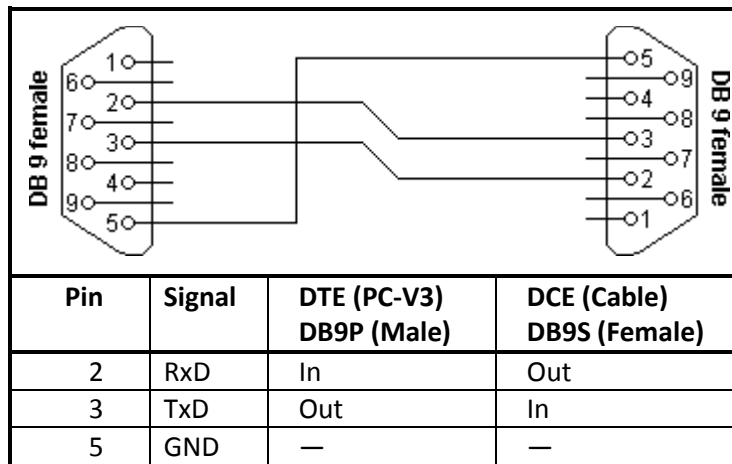

Figure 7: DB9F NULL MODEM

Sender V3 Getting Started Guide

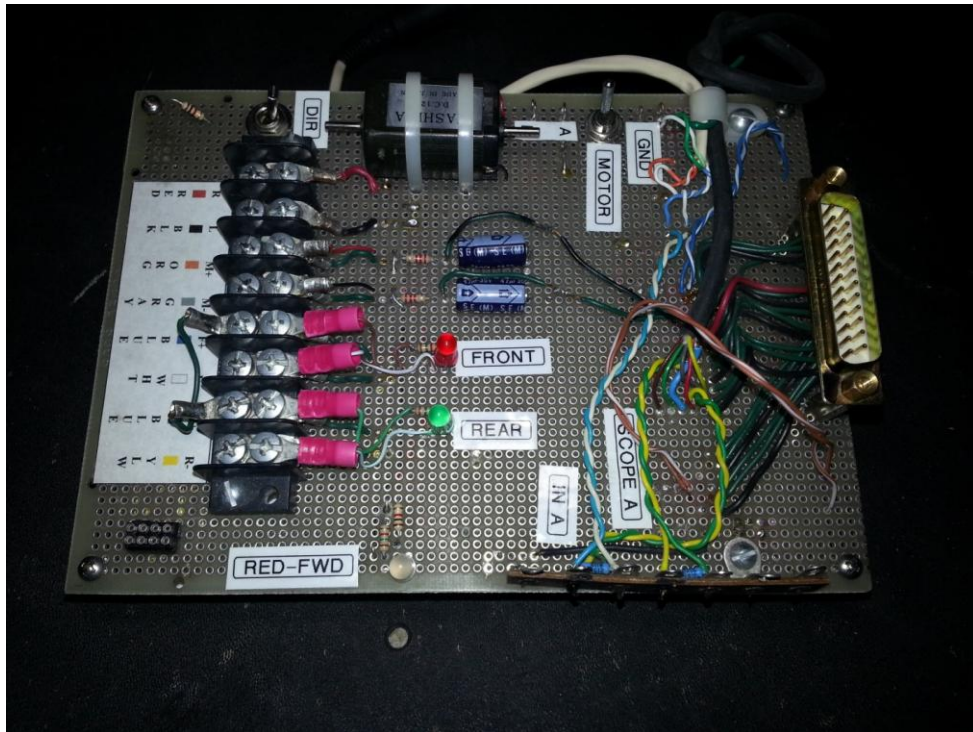

Figure 8: Example Test Jig

```
COM6:115200baud - Tera Term VT
File Edit Setup Control Window Help
version 2.55
Supports: Plug and Play
Portions written by Morien W. Roberts
Packet driver skeleton copyright 1988-93, Crynwr Software.
This program is freely copyable; source must be available; NO WARRANTY.
See the file COPYING.DOC for details; send FAX to +1-315-268-9201 for a copy.

An CS89X0 was found by I/O scan.
Reading EEPROM ....
Using twisted pair cable
System: [345]86 processor, Two 8259s
Packet driver software interrupt is 0x60 (96)
Interrupt number 0xC (12)
I/O port 0x300 (768)
My Ethernet address is 00:D0:69:14:98:67
rem run test program if JP5 is installed
[A:\]lecho off
JP5 not installed, skip test program
[A:\]
Change to C:\RESULTS
Technologic Systems web site is: (www.embeddedx86.com)
File System Version 1.00
[C:\RESULTS]
[C:\RESULTS]
```

Figure 9: V3 System Power-On Screen

Sender V3 Getting Started Guide

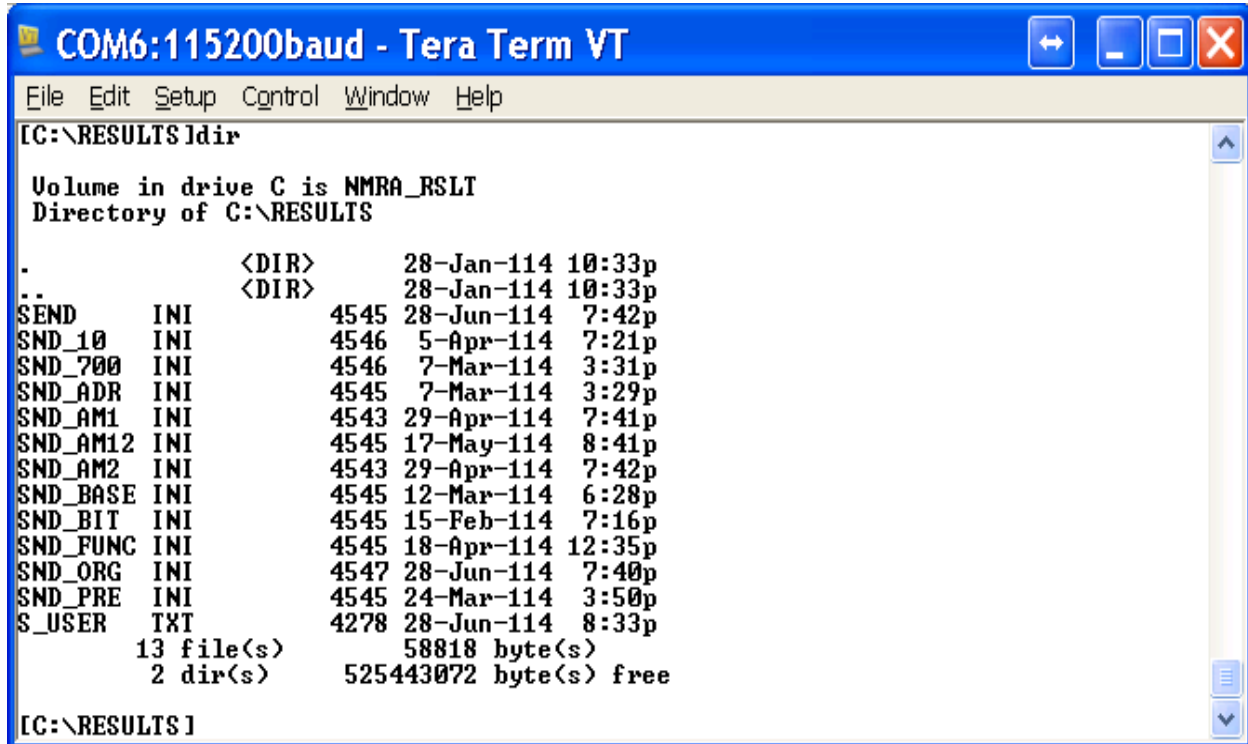

```
COM6:115200baud - Tera Term VT
File Edit Setup Control Window Help
[C:\RESULTS]dir

Volume in drive C is NMRA_RSLT
Directory of C:\RESULTS

.                <DIR>          28-Jan-114 10:33p
..               <DIR>          28-Jan-114 10:33p
SEND             INI             4545 28-Jun-114  7:42p
SND_10          INI             4546  5-Apr-114   7:21p
SND_700         INI             4546  7-Mar-114   3:31p
SND_ADR         INI             4545  7-Mar-114   3:29p
SND_AM1         INI             4543 29-Apr-114   7:41p
SND_AM12        INI             4545 17-May-114   8:41p
SND_AM2         INI             4543 29-Apr-114   7:42p
SND_BASE        INI             4545 12-Mar-114   6:28p
SND_BIT         INI             4545 15-Feb-114   7:16p
SND_FUNC        INI             4545 18-Apr-114  12:35p
SND_ORG         INI             4547 28-Jun-114   7:40p
SND_PRE         INI             4545 24-Mar-114   3:50p
S_USER          TXT             4278 28-Jun-114   8:33p
                13 file(s)         58818 byte(s)
                2 dir(s)         525443072 byte(s) free

[C:\RESULTS]
```

Figure 10: V3 System C:\RESULTS Directory

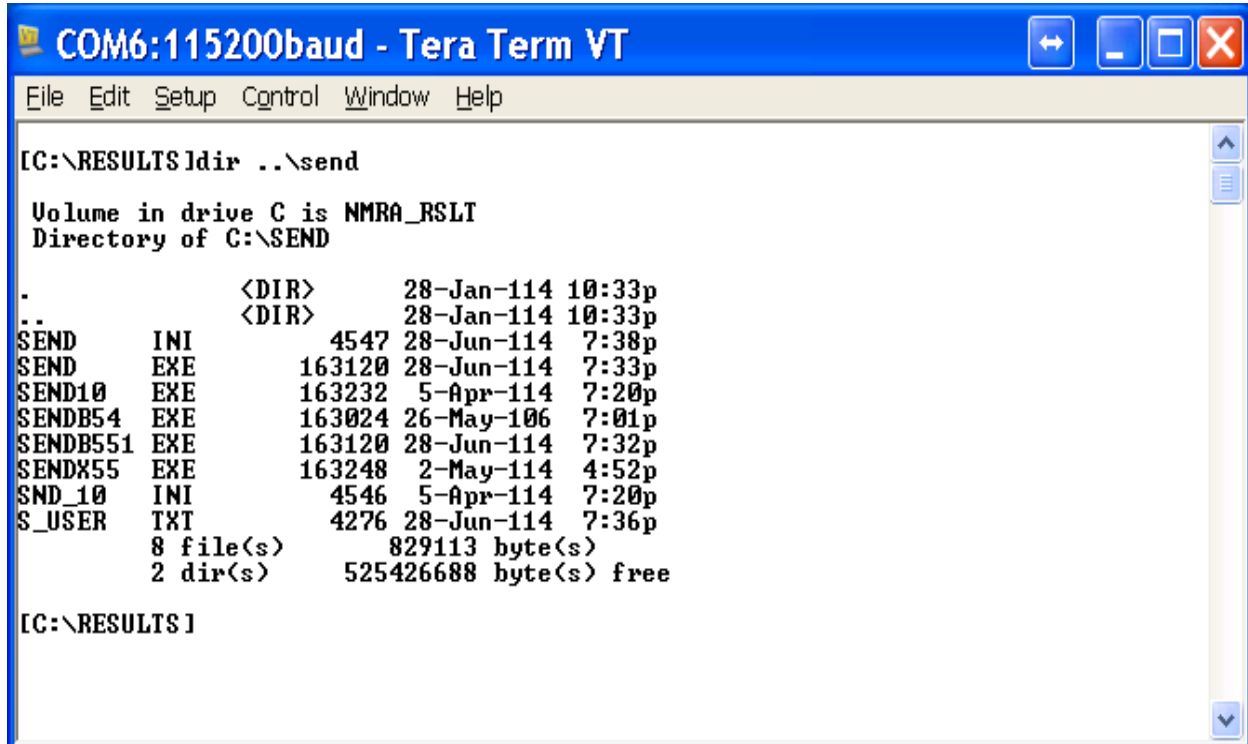

```
COM6:115200baud - Tera Term VT
File Edit Setup Control Window Help
[C:\RESULTS]dir ..\send

Volume in drive C is NMRA_RSLT
Directory of C:\SEND

.                <DIR>          28-Jan-114 10:33p
..               <DIR>          28-Jan-114 10:33p
SEND             INI             4547 28-Jun-114   7:38p
SEND             EXE            163120 28-Jun-114   7:33p
SEND10           EXE            163232  5-Apr-114   7:20p
SEND854         EXE            163024 26-May-106   7:01p
SEND8551        EXE            163120 28-Jun-114   7:32p
SENDX55         EXE            163248  2-May-114   4:52p
SND_10          INI             4546  5-Apr-114   7:20p
S_USER          TXT             4276 28-Jun-114   7:36p
                8 file(s)         829113 byte(s)
                2 dir(s)         525426688 byte(s) free

[C:\RESULTS]
```

Figure 11: V3 System C:\SEND Directory

Sender V3 Getting Started Guide

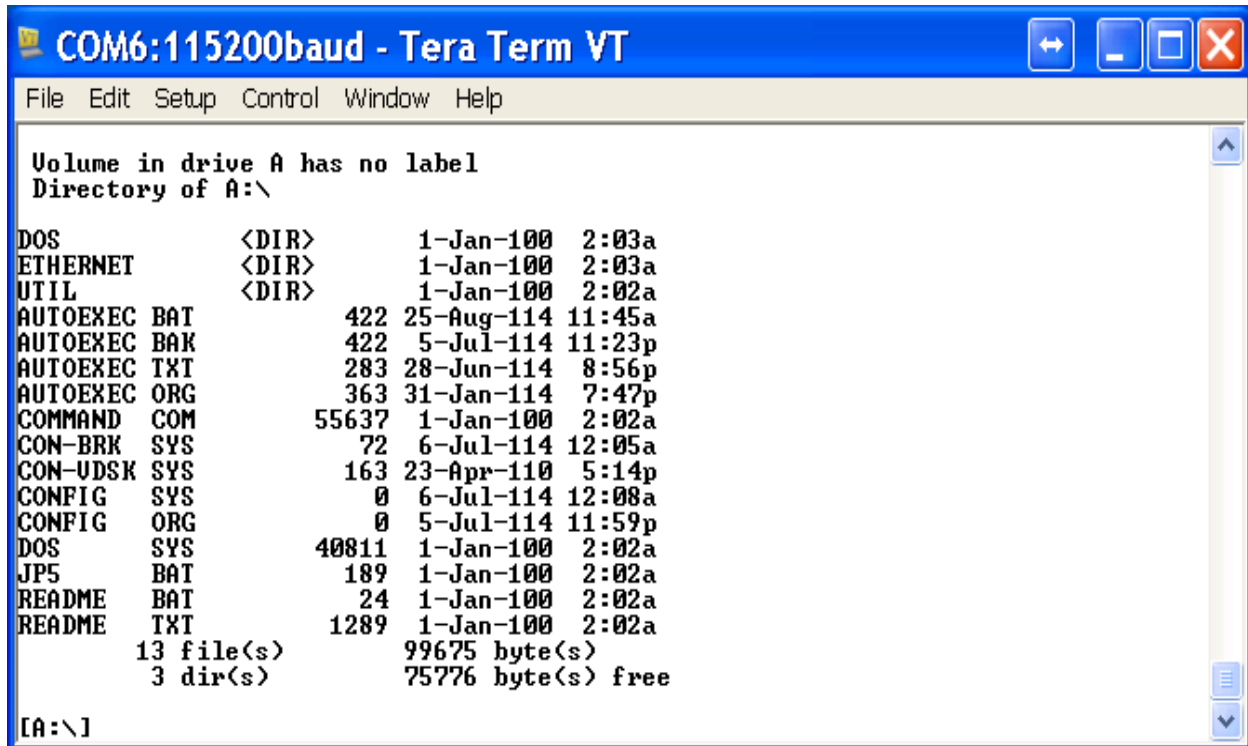

The screenshot shows a Tera Term VT window titled "COM6:115200baud - Tera Term VT". The window contains a directory listing for drive A:\. The listing shows 13 files and 3 directories. The files include DOS, ETHERNET, UTIL, AUTOEXEC.BAT, AUTOEXEC.BAK, AUTOEXEC.TXT, AUTOEXEC.ORG, COMMAND.COM, CON.BRK.SYS, CON.UDSK.SYS, CONFIG.SYS, CONFIG.ORG, DOS.SYS, JPS.BAT, README.BAT, and README.TXT. The listing also shows the total size of the files (99675 bytes) and the free space (75776 bytes).

```
COM6:115200baud - Tera Term VT
File Edit Setup Control Window Help

Volume in drive A has no label
Directory of A:\

DOS                <DIR>          1-Jan-100  2:03a
ETHERNET           <DIR>          1-Jan-100  2:03a
UTIL               <DIR>          1-Jan-100  2:02a
AUTOEXEC.BAT      422 25-Aug-114 11:45a
AUTOEXEC.BAK      422  5-Jul-114 11:23p
AUTOEXEC.TXT      283 28-Jun-114  8:56p
AUTOEXEC.ORG      363 31-Jan-114  7:47p
COMMAND.COM       55637 1-Jan-100  2:02a
CON.BRK.SYS       72  6-Jul-114 12:05a
CON.UDSK.SYS     163 23-Apr-110  5:14p
CONFIG.SYS        0  6-Jul-114 12:08a
CONFIG.ORG        0  5-Jul-114 11:59p
DOS.SYS          40811 1-Jan-100  2:02a
JPS.BAT          189  1-Jan-100  2:02a
README.BAT        24  1-Jan-100  2:02a
README.TXT       1289  1-Jan-100  2:02a
13 file(s)        99675 byte(s)
 3 dir(s)         75776 byte(s) free

[A:\]
```

Figure 12: V3 System A: Directory

Sender V3 Getting Started Guide

```

[C:\RESULTS]send -m
Test software version B.5.5.1
File <c:\send\send.EXE>
CRC 449673153, Length 163120
Enter base of log and statistics file name > temp
Enter Manufacturer > x
Enter Model number > x
Enter Serial number > x
Enter comments. Begin line with '.' to end input
.
Starting decoder tests, address 3, type L
Beginning self tests, this will take a few seconds
Self tests passed,          0 Cycles failed

Passed 1 test cycles, Failed 0 test cycles, test count 1
Failed 0 vector, 0 dynamic, 0 both, last vector 199
Dynamic 0 - min 99, avg 99, max 99
Dynamic 1 - min 99, avg 99, max 99
0xff 00001100 11111010   200 10110110 64393 10111010   2 00110110 1111
PC high 100( 90), low 100( 89)
PC 1 usec delay 1
Command mode (h for help, q to quit) >>d
Sending Loco Dcc packets, GEN 1111
Command mode (h for help, q to quit) >>f
Packets sent 590, Bytes sent 7858
Setting direction <BACK>, GEN 1111
Command mode (h for help, q to quit) >>q
Packets sent 466, Bytes sent 4893
[C:\RESULTS]
    
```

GEN bit 0

Figure 13: SEND.EXE Manual Mode

```

.
.
.
D          S C
C S          C P          O          O          O
CSH8D CU OAO IUCB          U          U          U
OCO2CDLN BCPCNCPD          TN          TN          TN
UOLGCKKD FKELTLUR          PU B          PU B          PU B
TPD0QC1E AANRRKES          ULRRMMC          ULRRMMC          ULRRMMC
PA DELHH0LR LLLLALNT          0T TL10210D          0H TL10210D          1T TL10210D GEN
-----
0xf8 00010001 11111000   18 00110110 65445 10111010   116 10110110 1111
Command mode (h for help, q to quit) >>
    
```

GEN bit 0

Figure 14: SEND.EXE Help Screen

Sender V3 Getting Started Guide

```
[C:\RESULTS] send
Test software version B.5.5.1
File <c:\send\send.EXE>
CRC 449673153, Length 163120
Enter base of log and statistics file name > AH101_4N
Enter Manufacturer > Acme
Enter Model number > H101
Enter Serial number > CV7=13
Enter comments. Begin line with '.' to end input
Conforming Booster, CV29=2 from 6
Normal Leads
.
Starting decoder tests, address 3, type L
Beginning self tests, this will take a few seconds
Self tests passed,          0 Cycles failed

Passed 1 test cycles, Failed 0 test cycles, test count 1
Failed 0 vector, 0 dynamic, 0 both, last vector 199
Dynamic 0 - min 98, avg 98, max 98
Dynamic 1 - min 99, avg 99, max 99
0xff 00001100 11111010   200 10110110 64393 10111010       2 00110110 1110
PC high 100( 90), low 100( 88)
PC 1 usec delay 1
Starting Decoder tests, type '<ESC> q' to stop tests
Starting Decoder test cycle   1
Beginning booster warm up
Completed booster warm up
Margin test for 1T clock, 12 preambles
  1T Margin:          Minimum 1T      81
  1T Margin:          Minimum 1T      81, Maximum 1T      137
.
.
.
  Ambig 2 <488, 440, 122, 61> PAddr   2: Tests   2; Passes   2, 100%
  Ambig 2 <488, 439, 122, 61> PAddr   2: Tests   2; Passes   2, 100%
  Ambig 2 <488, 438, 122, 61> PAddr   2: Tests   2; Passes   2, 100%
  Ambig 2 <488, 437, 122, 61> PAddr   2: Tests   2; Passes   2,
100%All tests have currently passed
Tests COMPLETED, All tests passed
[C:\RESULTS]
```

Figure 15 SEND.EXE Automated Test

Sender V3 Getting Started Guide



Figure 16: Serial Loopback Connection

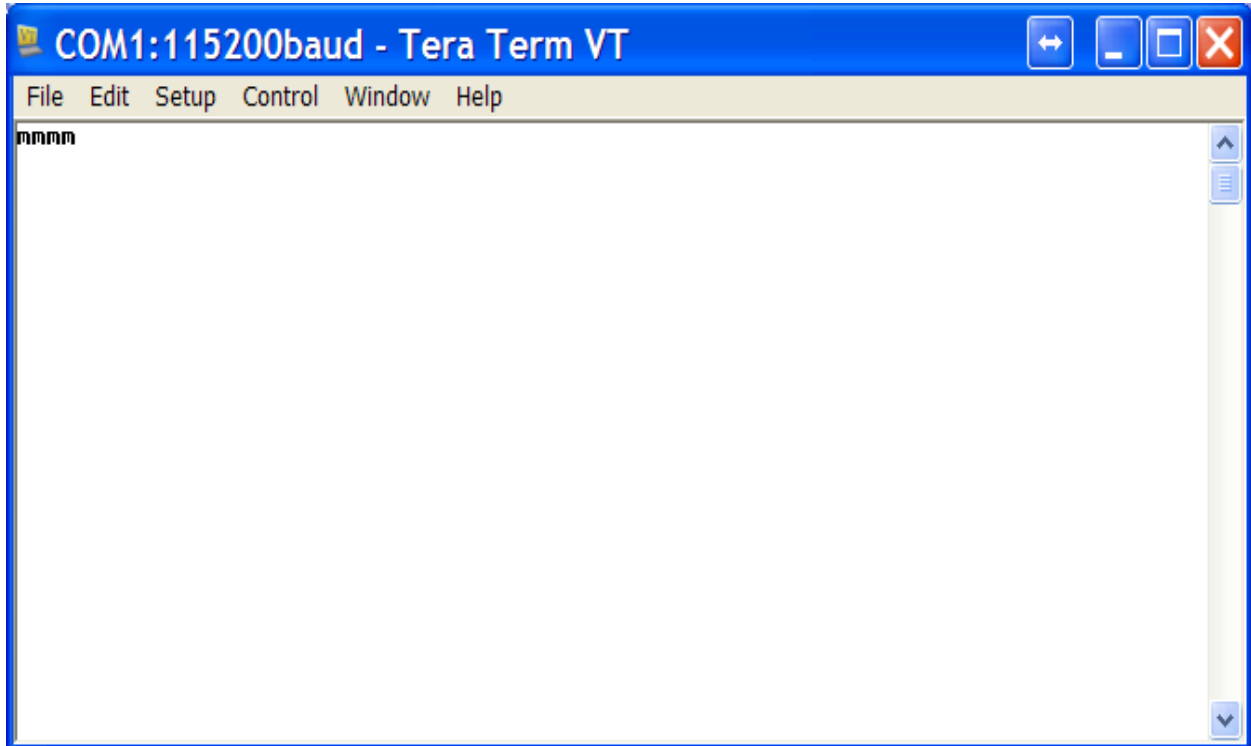

Figure 17: Loopback Terminal Emulator Screen

Sender V3 Getting Started Guide

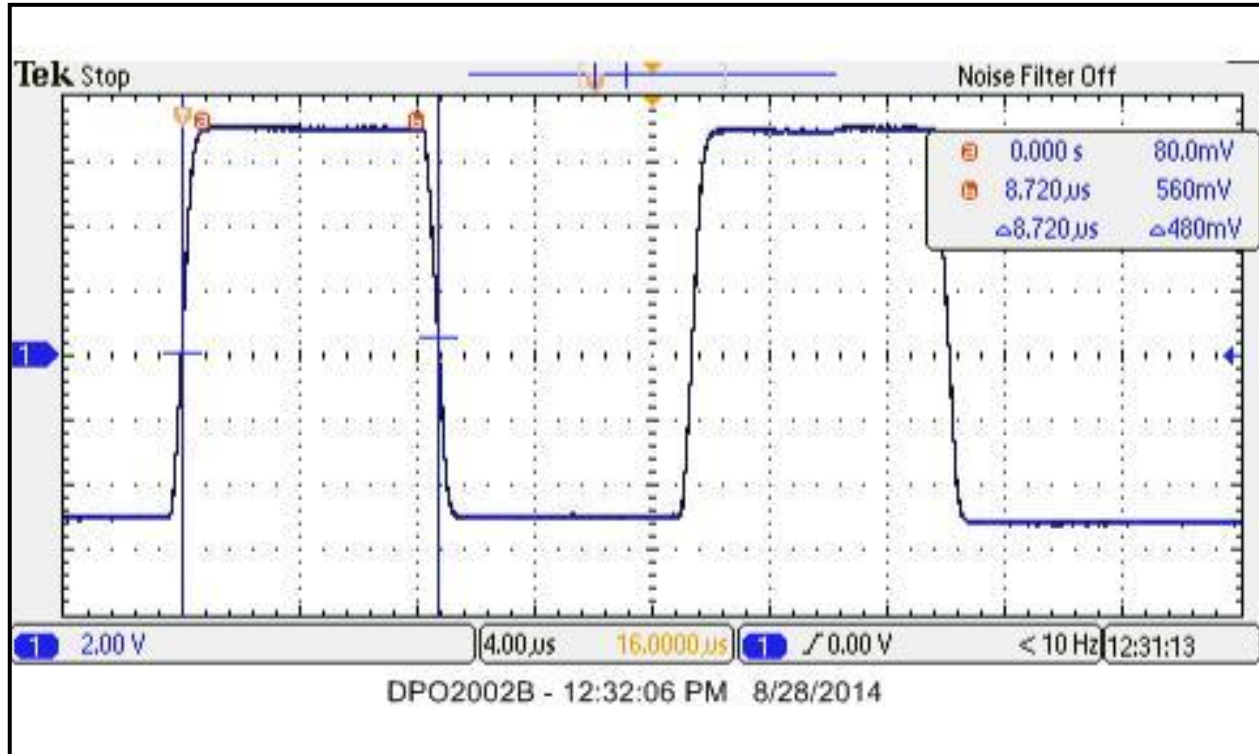

Figure 18: Loopback Scope Trace

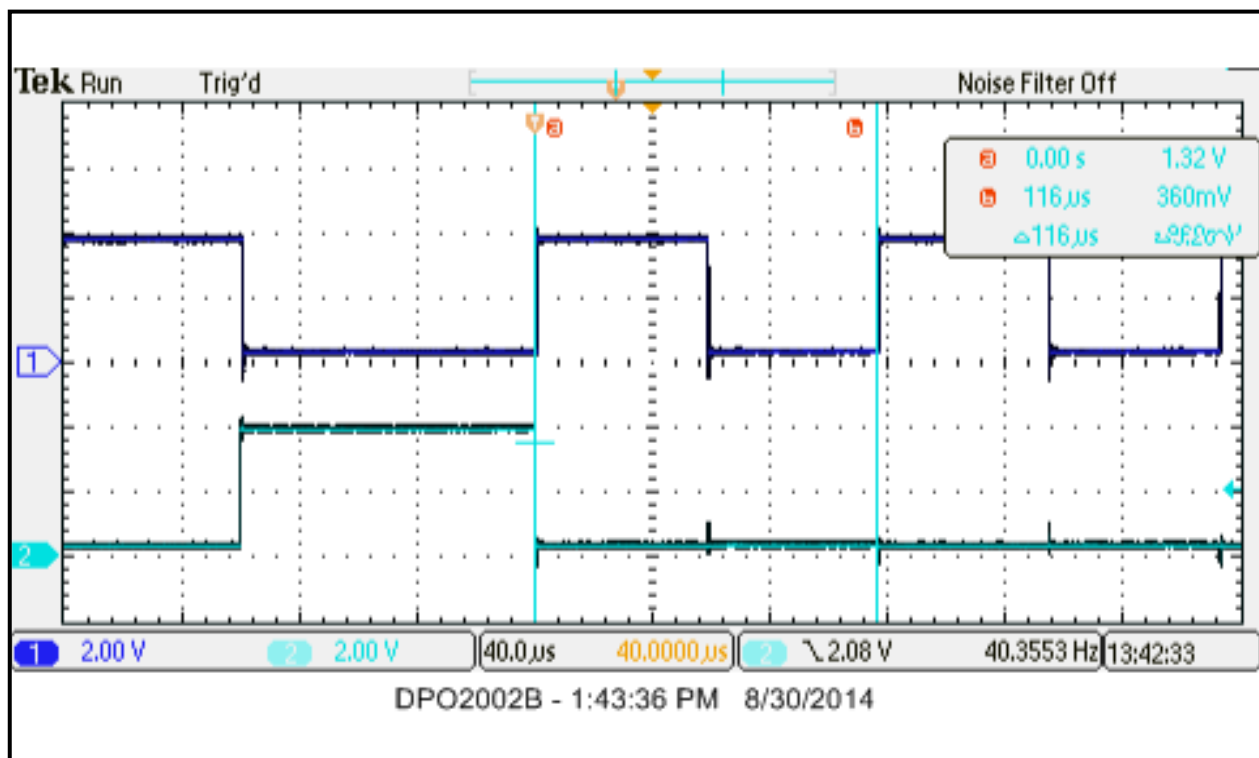

Figure 19: Scope Trigger Trace

Sender V3 Getting Started Guide

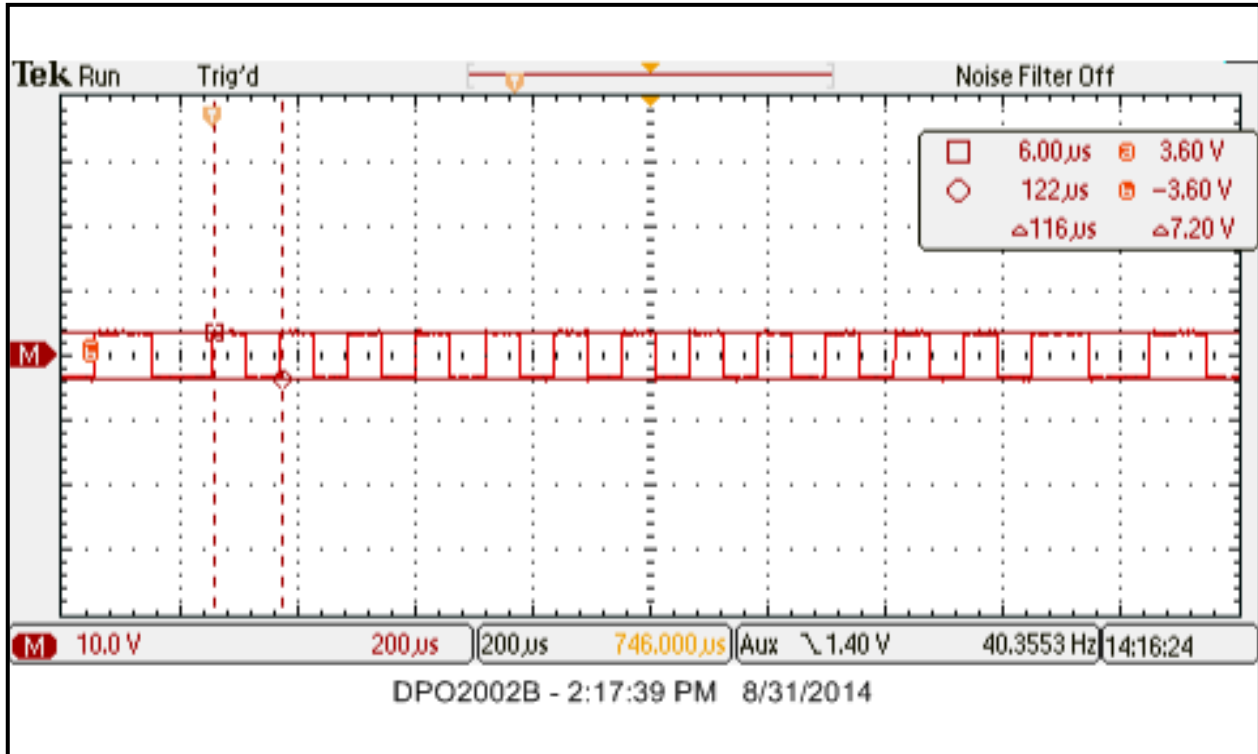

Figure 20: DCC A – DCC B Trace

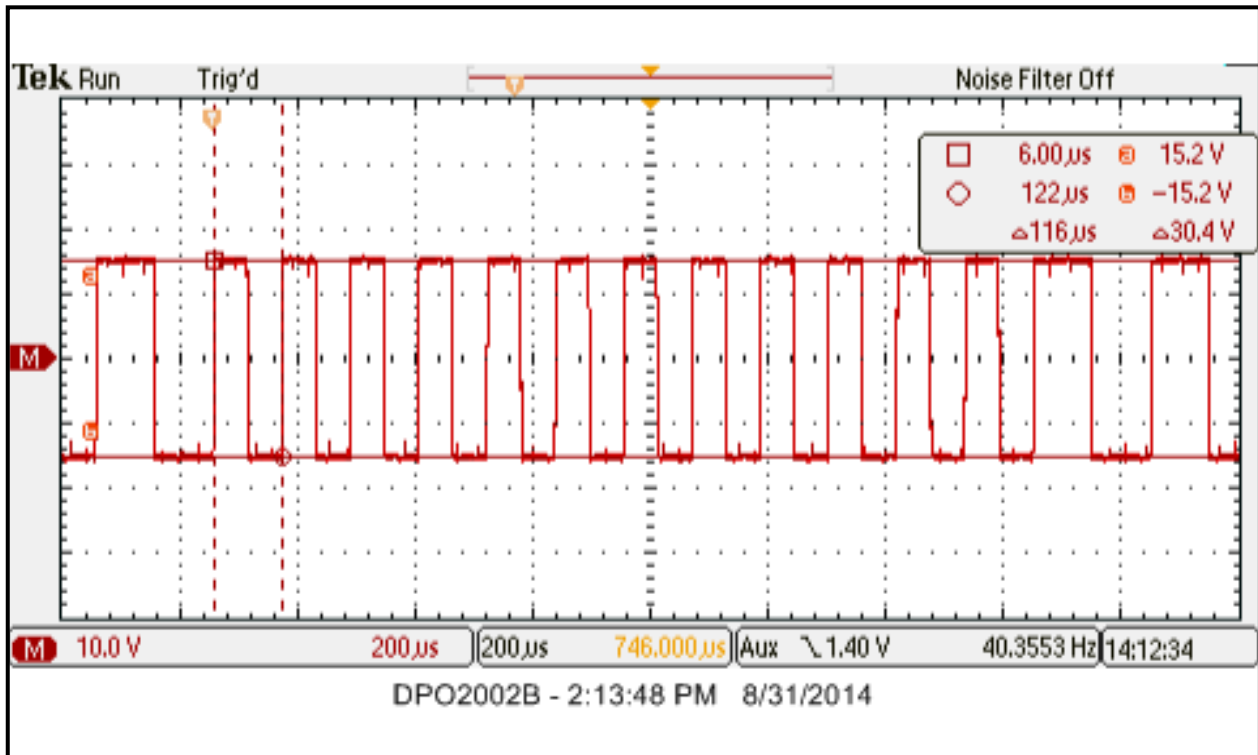

Figure 21: Booster Output Trace